

  
**LOCATOR R-Tx<sup>®</sup>**  
REMOVABLE ATTACHMENT SYSTEM

# LOCATOR R-Tx<sup>®</sup>

## TECHNIQUE MANUAL

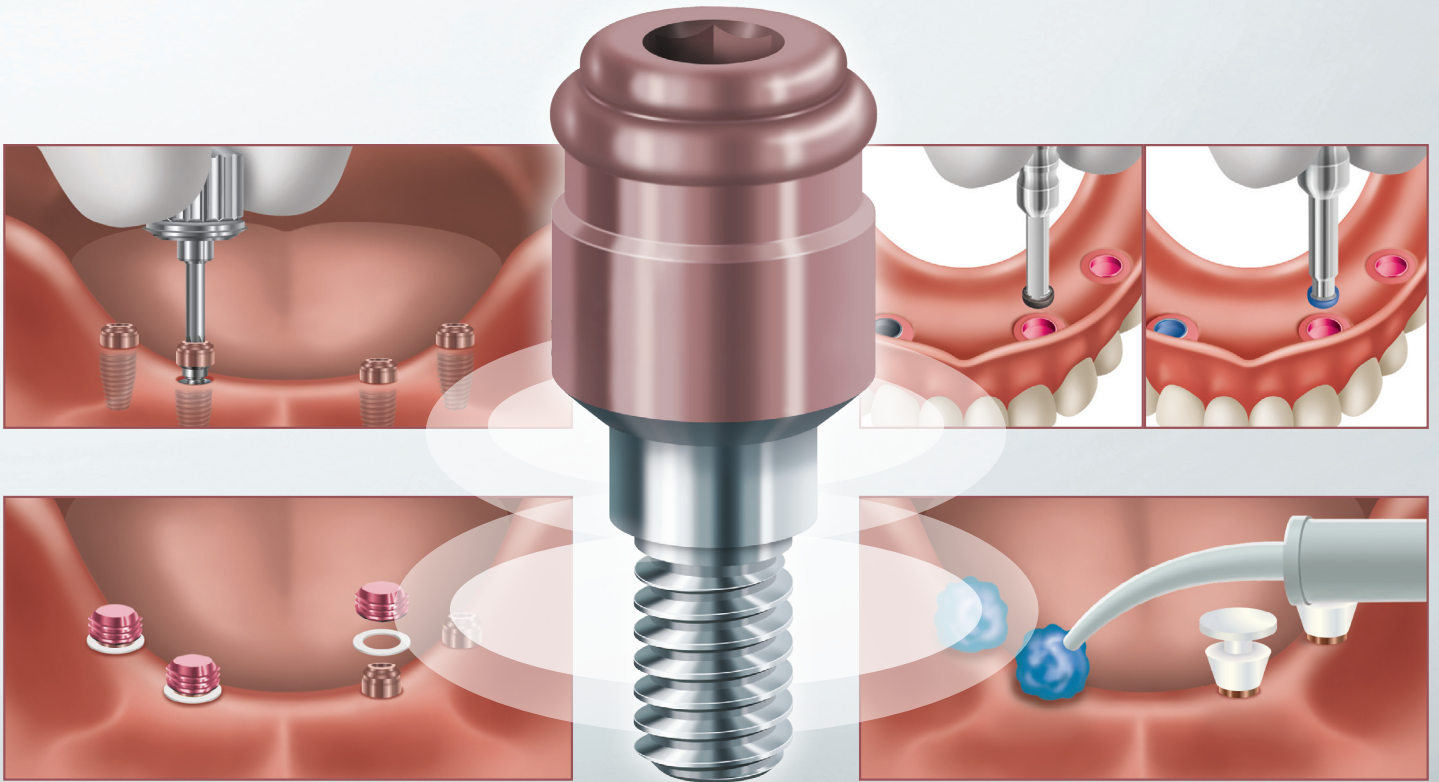

# TABLE OF CONTENTS

- 2 LOCATOR R-Tx® COMPONENTS REFERENCE
- 3 THE NEXT GENERATION OF THE WORLD'S LEADING OVERDENTURE ATTACHMENT SYSTEM
- 4 OVERVIEW OF SYSTEM FEATURES
- 7 ABUTMENT PLACEMENT
- 8 PROCESSING DENTURE ATTACHMENT HOUSINGS INTO THE DENTURE – DIRECT TECHNIQUE
- 11 PROCESSING DENTURE ATTACHMENT HOUSINGS INTO THE DENTURE – INDIRECT TECHNIQUE
- 15 MAINTENANCE OF THE LOCATOR R-Tx ABUTMENT – RELINE OF IMPLANT-RETAINED TISSUE SUPPORTED OVERDENTURES
- 18 RETURN POLICY AND WARRANTY

**IMPORTANT:** This document is designed to serve as a reference guide for dental clinicians using Zest Dental Solutions® products. It is not intended to be a substitute for professional training and experience. Please refer to the Instructions For Use (L8124-ZD) for further information.

# LOCATOR R-Tx® COMPONENTS REFERENCE

## LAB PROCESSING

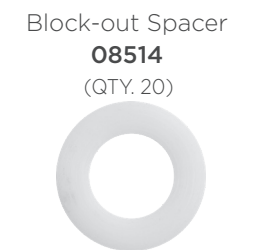

## RETENTION INSERTS



## TOOLS



# LOCATOR R-Tx®

The Next Generation of the World's Leading Overdenture Attachment System

Unveiling LOCATOR R-Tx, a better, simpler, and stronger system that relies on the same restorative techniques as the award-winning LOCATOR®.

At Zest Dental Solutions®, we proudly claim a heritage of over 40 years in overdenture attachment innovation.

Over the past decade and a half, the LOCATOR Attachment System has grown dramatically, evolving into the undisputed market leader for implant-retained, tissue-supported overdenture attachments. Trusted by the industry, the clinician community, and patients alike.

In keeping with our innovative spirit, Zest has continued to refine and even reimagine LOCATOR. We started by listening to you, the influential specialists, clinicians, and manufacturers. Then, our engineers put those ideas to the test and into real application.

Welcome to LOCATOR R-Tx.

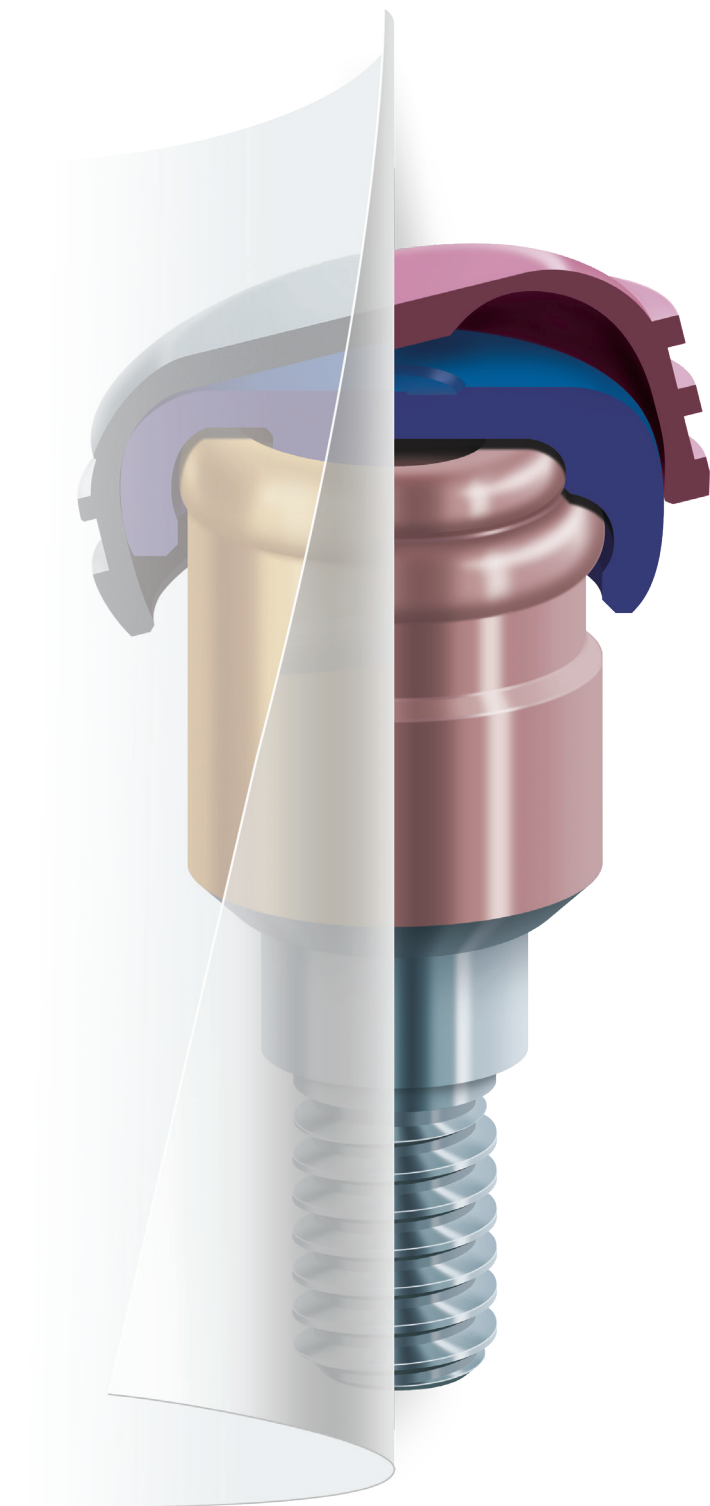

# LOCATOR R-Tx®

Overview of System Features

## ABUTMENT

1 Dual retentive surfaces for engagement and narrower coronal geometry for easier seating of overdenture.



2 Industry standard .050"/1.25mm\* hex drive mechanism.

3 DuraTec® Titanium Carbon Nitride Coating is aesthetic, harder and more wear resistant.

## DENTURE ATTACHMENT HOUSING/ RETENTION INSERT

1 50% increase in pivoting capability up to 30 degrees between implants.

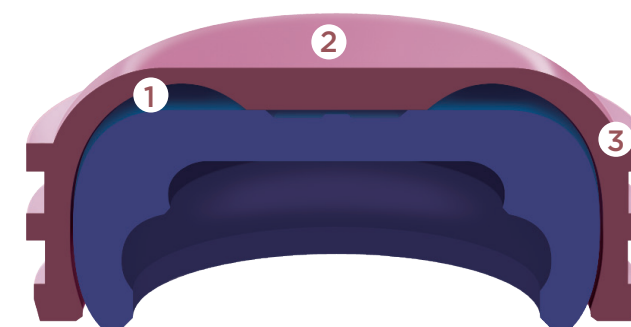

2 Pink anodization for improved aesthetics

3 Flats & grooves for enhanced fixation



### 1 EASIER DENTURE SEATING WITH PIVOTING TECHNOLOGY

The magic of LOCATOR® has been that the Nylon Retention Insert pivots within the Denture Attachment Housing during insertion/removal, resulting in a resilient system that has allowed patients to seat their overdenture without damaging the components, even in the presence of divergence or convergence between implants.

Patented modifications to the Denture Attachment Housing now allow the Housing to pivot up to 30° over the seated LOCATOR R-Tx Nylon Retention Inserts eliminating the need for pre-angled abutments.

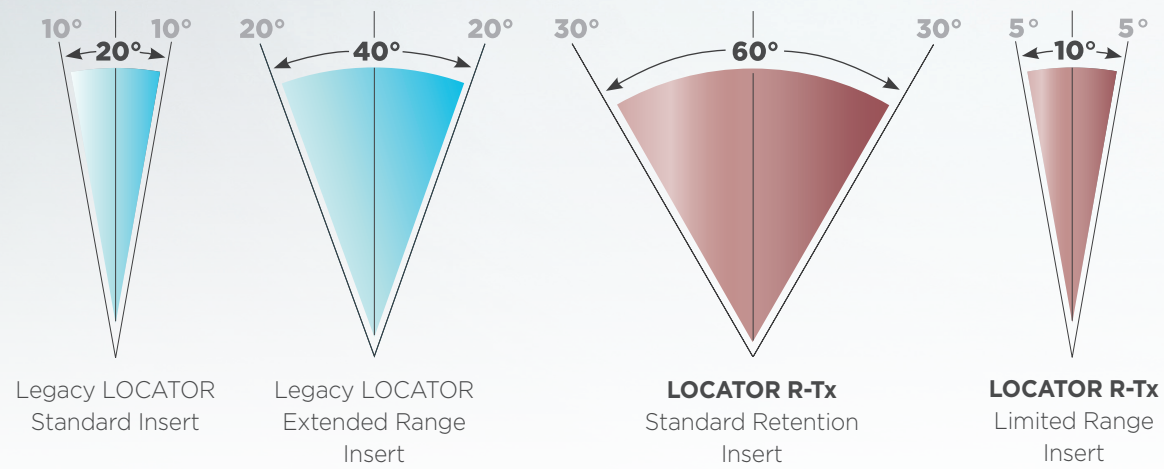

### 2 NARROWER CORONAL GEOMETRY

The dual engaging geometry of the abutment offers a narrower leading edge and taper-like effect to allow the patient to more easily align and properly seat the overdenture.

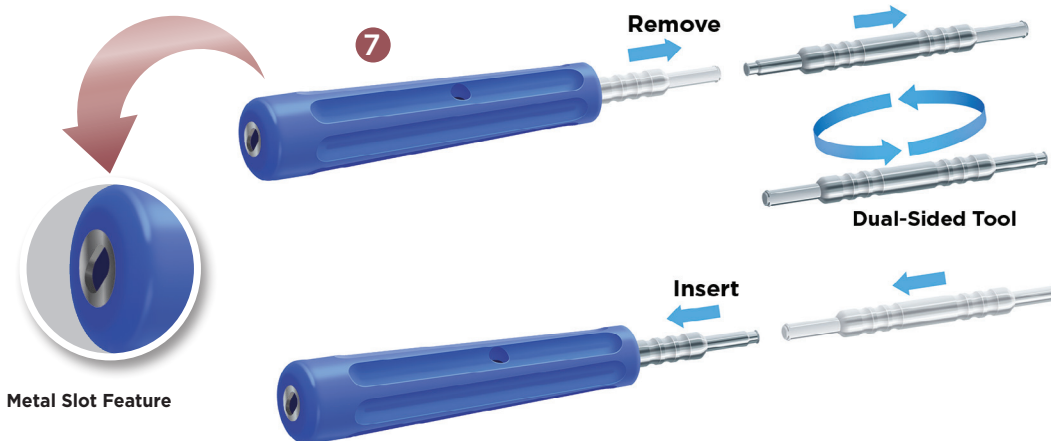
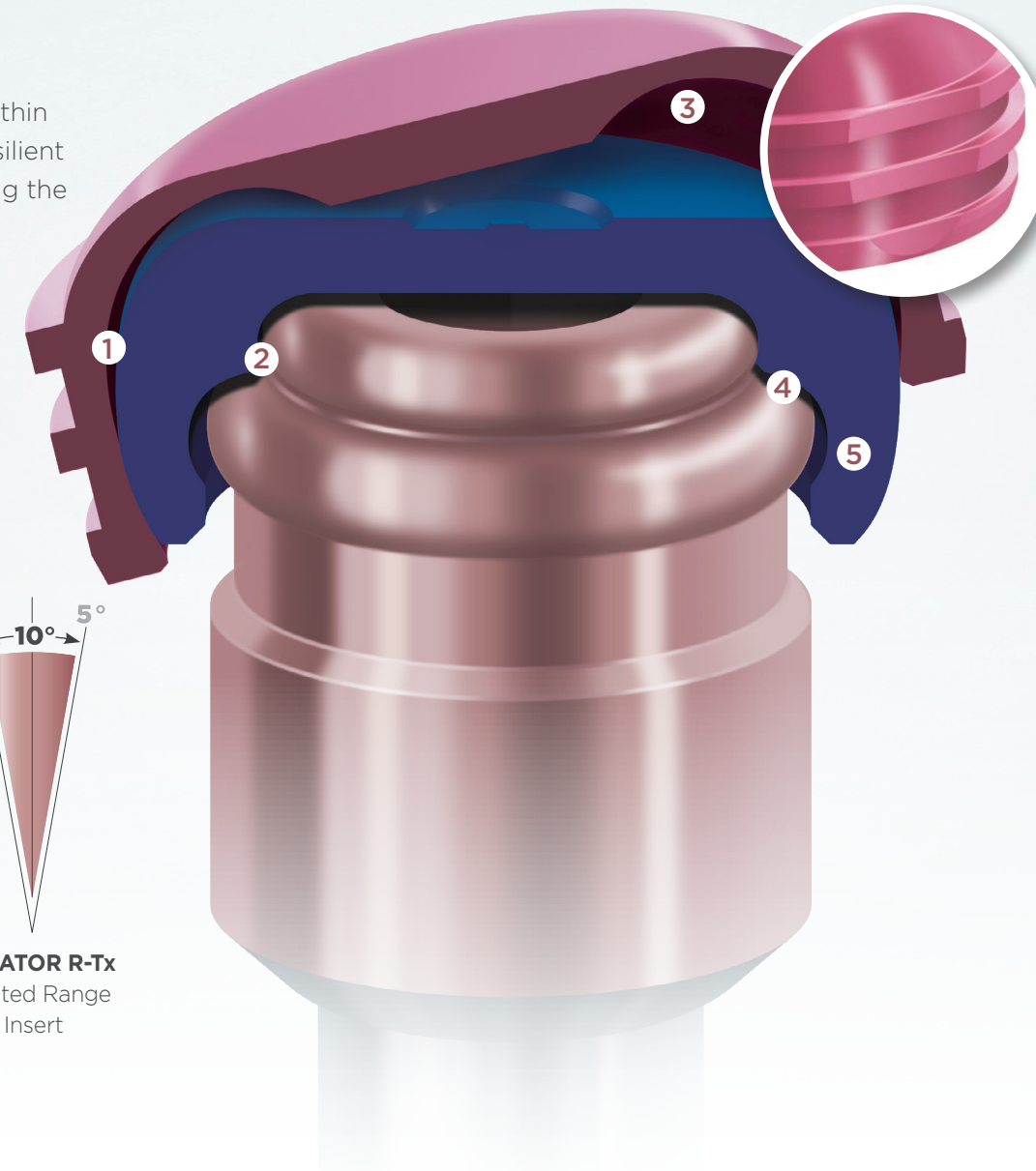
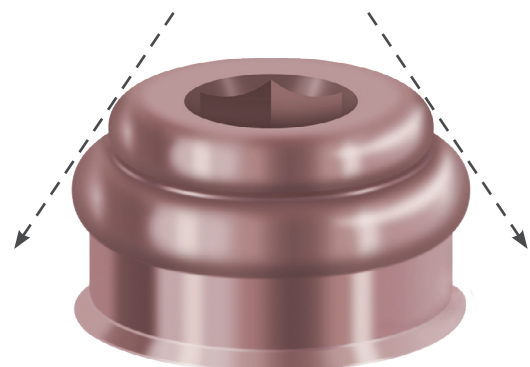

### 3 PRACTICAL DENTURE ATTACHMENT HOUSING DESIGN

Horizontal grooves and flats resist vertical and rotational movement and a channel inside the top of the Housing enhances pivot range of motion. New pink anodization improves aesthetics in areas of thin denture acrylic.

### 4 EFFICIENT ABUTMENT/INSERT ENGAGEMENT

The Nylon Retention Inserts now engage dual retentive surfaces on the exterior of the Abutment. This helps prevent debris and plaque accumulation within the drive mechanism from impacting proper seating.

### 5 RETENTION INSERT DESIGN

The system now offers two ranges of inserts allowing the clinician to customize retention based on the patients preferences and needs. Both sets offer Low, Medium and High retention.

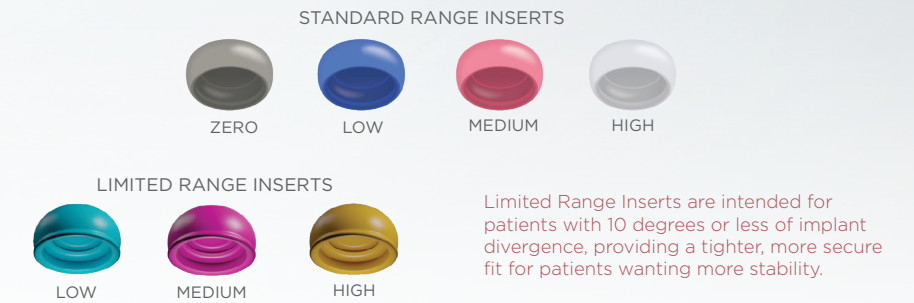

### 6 CONVENIENT ALL-IN-ONE PACKAGING

Custom designed all-in-one, double-ended vial separately holds Abutment and Processing Components providing all the necessary components for the case with one part number.



### 7 CUSTOM RETENTION INSERT TOOL

Dual-Sided Tool for easy insertion and removal of the LOCATOR R-Tx® Retention Insert. Metal slot feature on the back of the Tool Handle allows the clinician to disengage a Retention Insert without the risk of tearing gloves.



# LOCATOR R-Tx®

## Abutment Placement

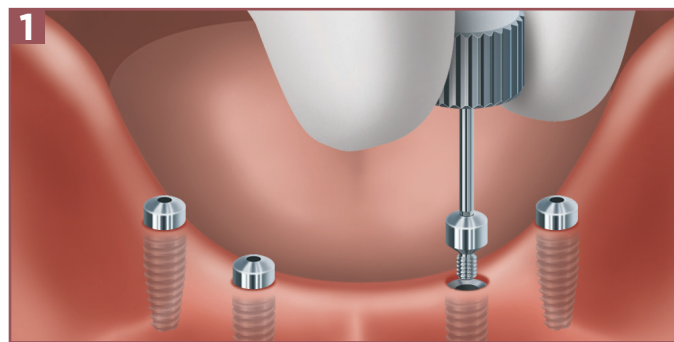

**1** Identify the system and diameter of each implant. Remove the healing abutments.

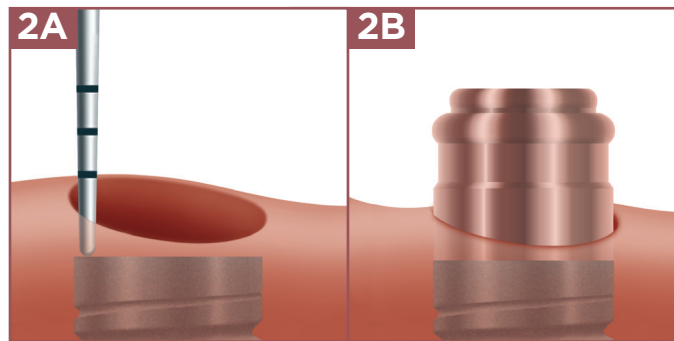

**2A-2B** Using a periodontal probe, measure the height of the gingiva at the highest point and select the cuff height of the LOCATOR R-Tx Abutment that corresponds to that measurement. If it is 2mm, choose a 2mm cuff height. An additional 2mm of Abutment height will extend above the gingiva to accommodate the seated Denture Attachment Housing and Nylon Retention Insert.

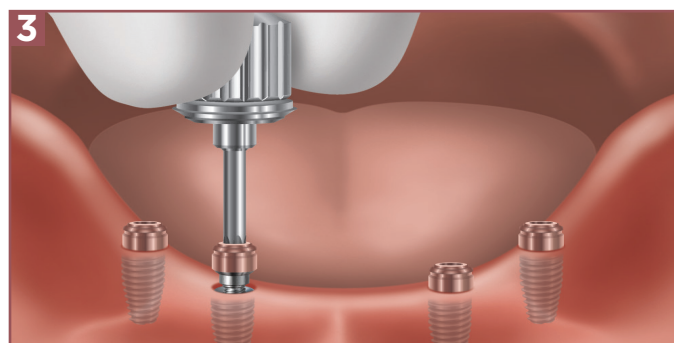

**3** Place the LOCATOR R-Tx Abutment into the implant using a .050"/1.25mm\* hex driver and hand tighten. Radiograph each interface to confirm that the Abutments are fully seated on the implants by placing the film perpendicular to the interface.

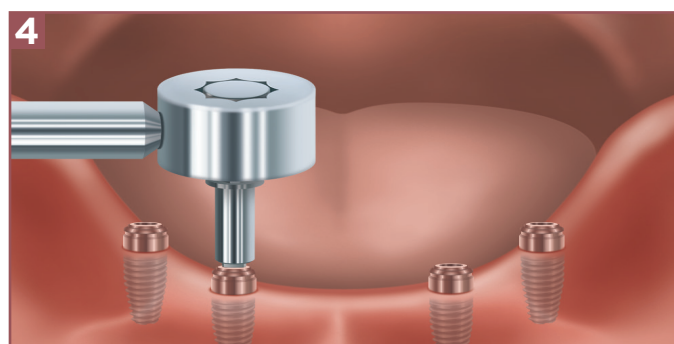

**4** Complete the seating of the R-Tx Abutment by using a calibrated torque wrench. Tighten the LOCATOR R-Tx Abutment to 30Ncm.

**NOTE:** LOCATOR R-Tx Abutments designed for implants with an internal thread diameter of  $\leq 1.4\text{mm}$  must be torqued to 20Ncm. The use of higher torque values than recommended could cause a fracture of the LOCATOR R-Tx Abutment.

A direct or indirect technique may be used for processing the Denture Attachment Housings into the overdenture. Please refer to page 8 for direct and page 11 for indirect processing techniques for the LOCATOR R-Tx Removable Attachment System.

# LOCATOR R-Tx®

## Processing Denture Attachment Housings into the Overdenture - Direct Technique

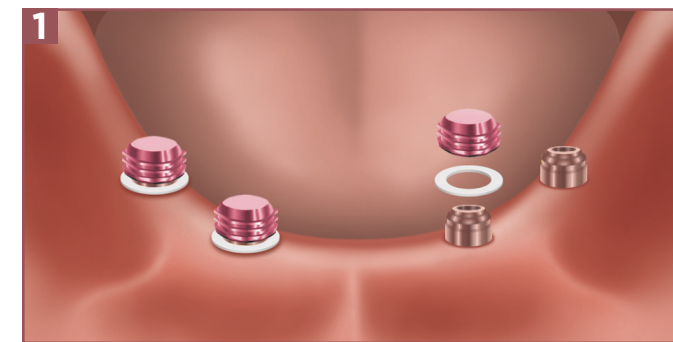

**1** Place a white Block-Out Spacer around each Abutment and press it down to the tissue. Snap a Denture Attachment Housing with a pre-loaded Black Processing Insert onto each Abutment, pressing down firmly.

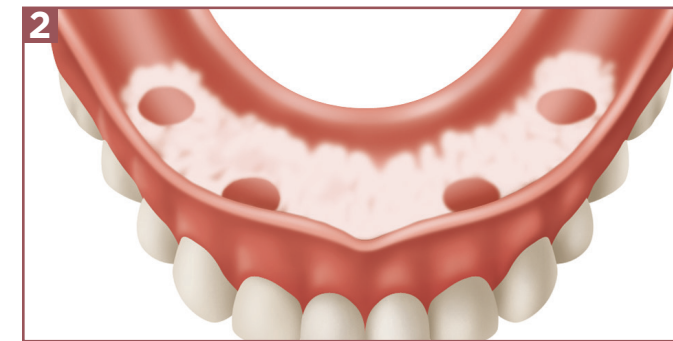

**2** Apply fit check marking paste to the intaglio surface of the denture. Insert it into the mouth in position over the Denture Attachment Housings. This will mark areas where the denture will need to be relieved to allow space for the Housings to be picked up.

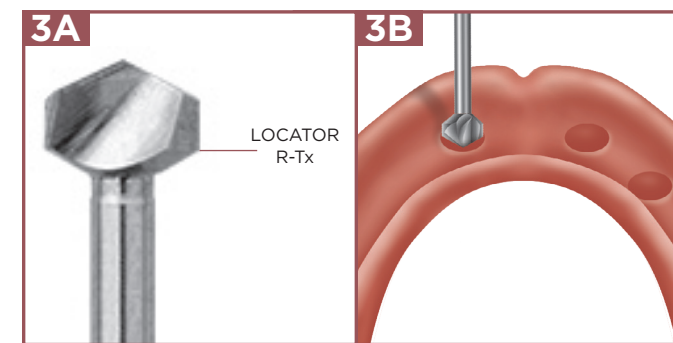

**3A-3B** Relieve the marked areas with the CHAIRSIDE® Recess Bur. Zest recommends using slight pressure and a small rocking motion to get the tip of the Bur started, followed by a straight downward motion to create the desired recess site. This Bur has distinct depth landmarks which indicate where to stop when drilling for the Denture Attachment Housing.

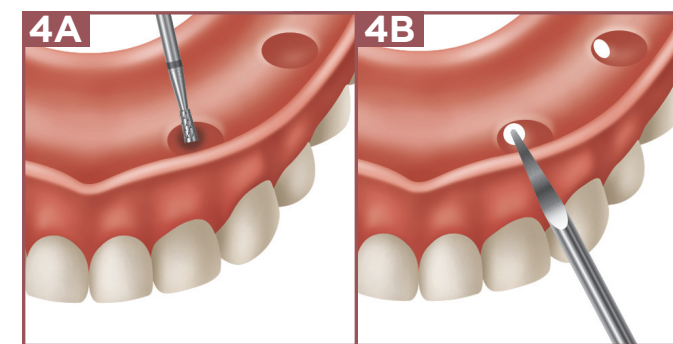

**4A-4B** Use the CHAIRSIDE Undercut Bur to cut an undercut around the circumference of the relief areas for mechanical retention. Cut lingual/palatal vent windows in the overdenture with the CHAIRSIDE Vent Bur to visualize full seating and for excess material to vent.

## LOCATOR R-Tx®

### Processing Denture Attachment Housings into the Overdenture - Direct Technique (continued)

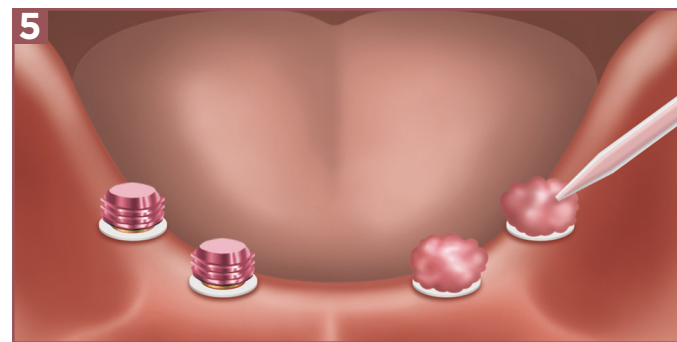

**5** Dry the Denture Attachment Housings. Apply a small amount of CHAIRSIDE® Attachment Processing Material around the circumference of each Housing. Place CHAIRSIDE Material into the relief areas of the overdenture and seat it over the Housings and onto the tissue. Have the patient close into light occlusion and hold while the CHAIRSIDE Material sets. Please refer to CHAIRSIDE Attachment Processing Material IFU (L8121-ZD) for set times.

**NOTE: Excessive occlusal pressure during the setting time may cause tissue recoil against the denture base and could contribute to dislodging and premature wear of the Inserts.**

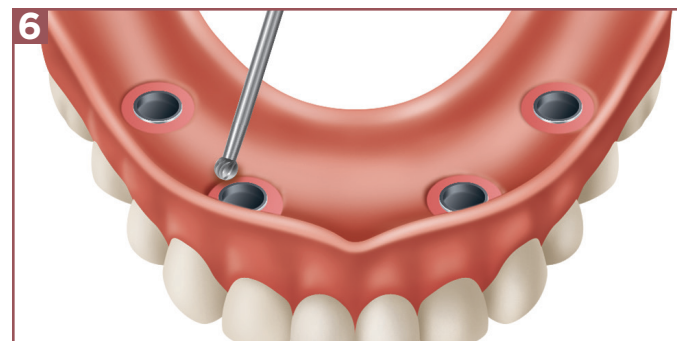

**6** Disengage the overdenture from the Abutments and remove from the mouth. Verify that the Denture Attachment Housings have been securely processed into the overdenture. Fill any voids with CHAIRSIDE Material and light cure. The material will bond to itself and will cure within 30 seconds with light application. Remove any excess material with the CHAIRSIDE Grind Bur.

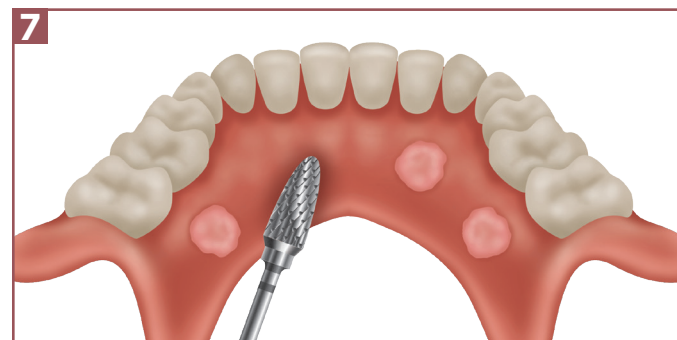

**7** Use the CHAIRSIDE Trim Bur to remove any excess acrylic material and to make any needed modifications to the overdenture.

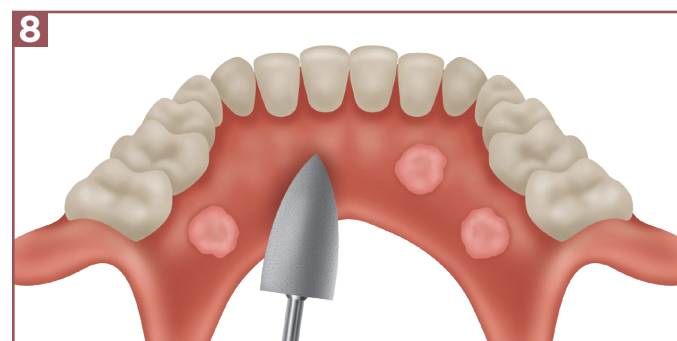

**8** Use the CHAIRSIDE Polish Bur to create a smooth finish of the overdenture.

## LOCATOR R-Tx®

### Processing Denture Attachment Housings into the Overdenture - Direct Technique (continued)

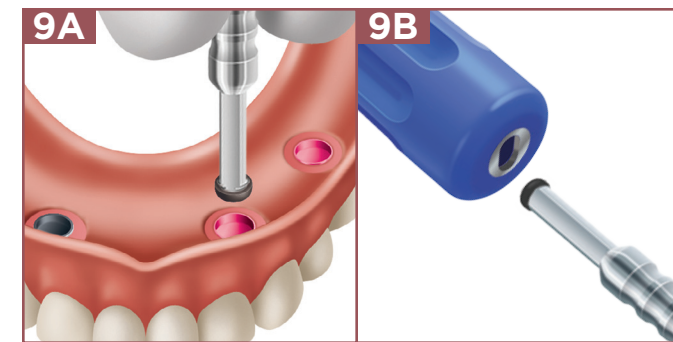

**9A-9B** Remove the Black Processing Insert from the Denture Attachment Housing using the removal (OUT) end of the Retention Insert Tool. When using the removal end of the Tool, engage the Processing Insert and tip the Tool towards the distal or mesial of the intaglio surface until the Insert completely disengages from the Denture Attachment Housing.

Use the metal slot feature on the back end of the Tool to remove the Insert from the tip of the Tool. This can be accomplished by sliding the Insert into the opening of the metal slot and using an upward motion to remove the Insert.

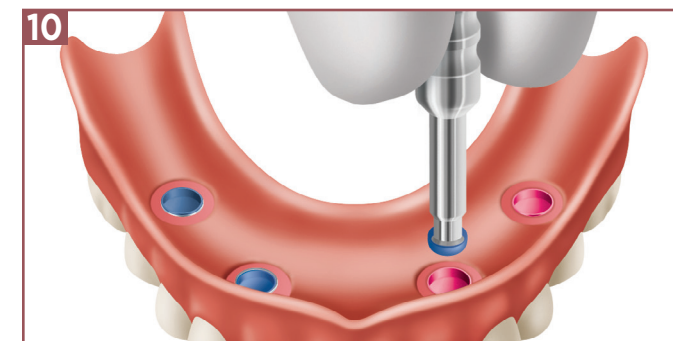

**10** Place the selected final Retention Insert into each Denture Attachment Housing using the insertion (IN) end of the Tool. During try-in, start with the lowest retentive option. When using the insertion end of the Tool, engage the Retention Insert from a slight angle and upright the Tool while pressing down.

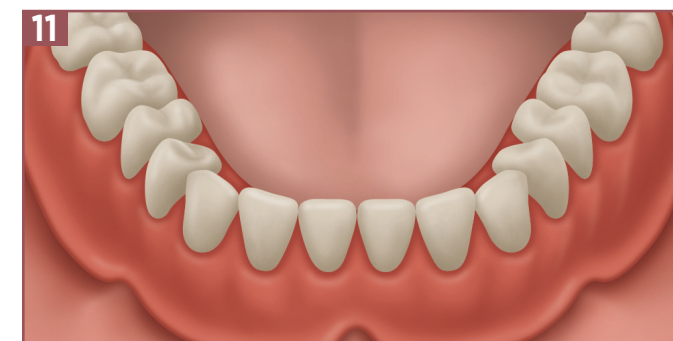

**11** Seat the overdenture, press down to engage the Inserts on the LOCATOR R-Tx Abutments and verify the occlusion. Instruct the patient on how to remove and insert the overdenture. If the retention is not satisfactory, remove the Inserts and replace with the next level of retention. Please refer to the Retention Inserts section of the Components Reference on page 2 for available levels of retention. Instruct the patient on proper home care maintenance and required recall visits.



# LOCATOR R-Tx®

## Processing Denture Attachment Housings into the Overdenture - Indirect Technique

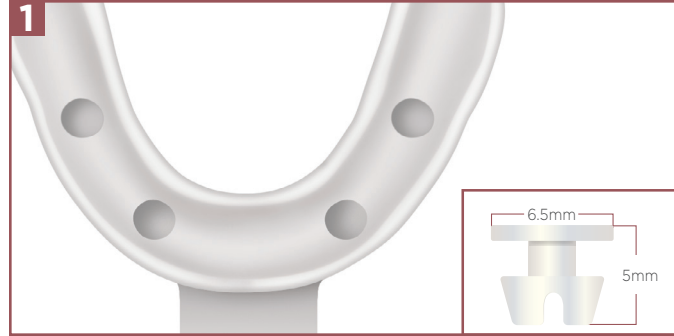

### 1 INDIRECT TECHNIQUE/LABORATORY PROCESSING

A stock or custom impression tray may be used. Ensure that each recess has enough space for the height and diameter of the LOCATOR R-Tx Impression Copings.

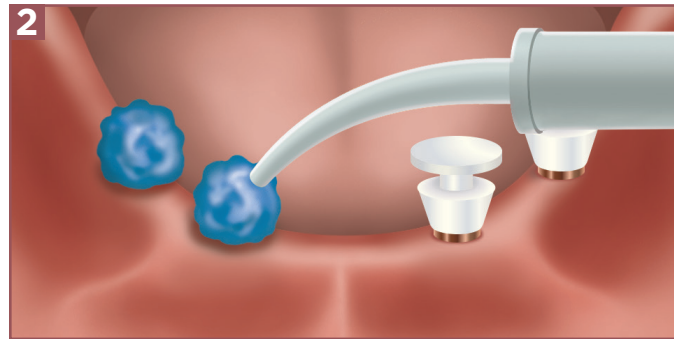

2 Place a LOCATOR R-Tx Impression Coping on each Abutment and press down firmly. Syringe a medium body impression material around the circumference of each coping. Fill the impression tray and insert it over the copings and onto the tissue. Allow the material to set and remove the impression tray.

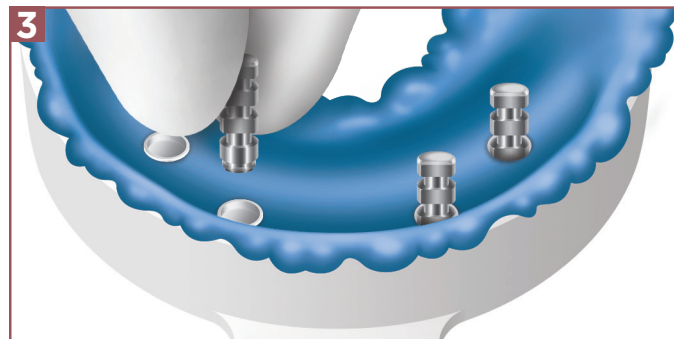

3 Seat the appropriate diameter LOCATOR R-Tx Analog into each Impression Coping and send the impression to the laboratory.

# LOCATOR R-Tx®

## Processing Attachment Housings into the Overdenture - Indirect Technique (continued)

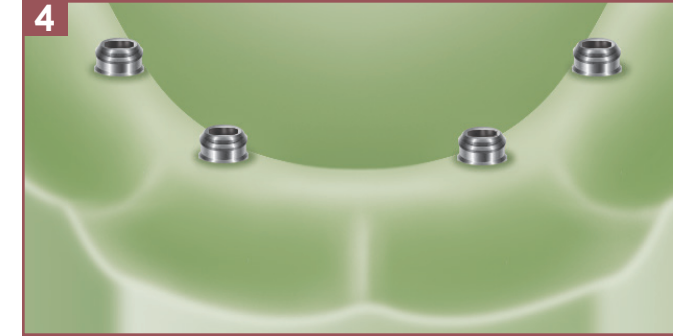

4 Verify that the Analogs are secure in the Impression Copings and pour a model.

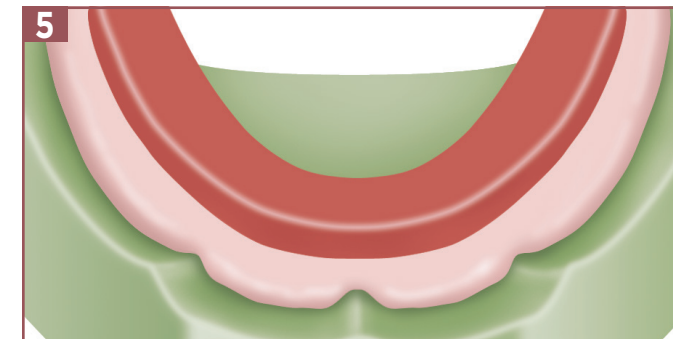

5 Fabricate the baseplate and wax rim on the cast for the bite registration. The Denture Attachment Housings with Black Processing Inserts may be processed into the baseplate to provide stabilization during record making and try-in.

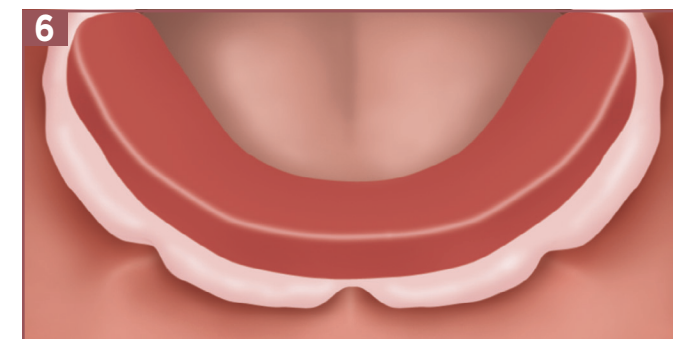

### 6 BITE RECORDS

Place the bite block into the mouth and record the jaw relation. Take an impression of the opposing arch and pour the cast. Select a shade for the denture teeth.

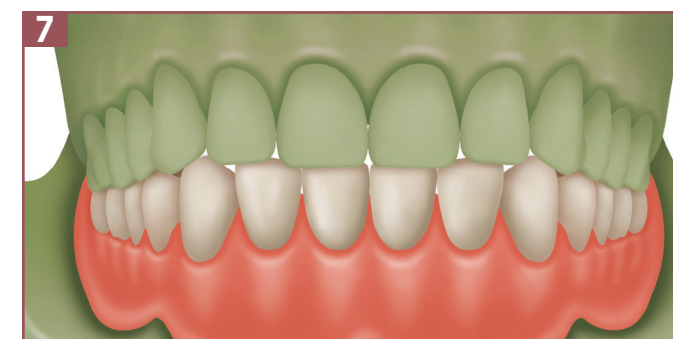

7 Articulate the models and proceed with the denture teeth set up.



**8 OVERDENTURE TRY-IN**  
Place the try-in overdenture into the mouth and verify the fit, attachment engagement, aesthetics, phonetics and occlusion.

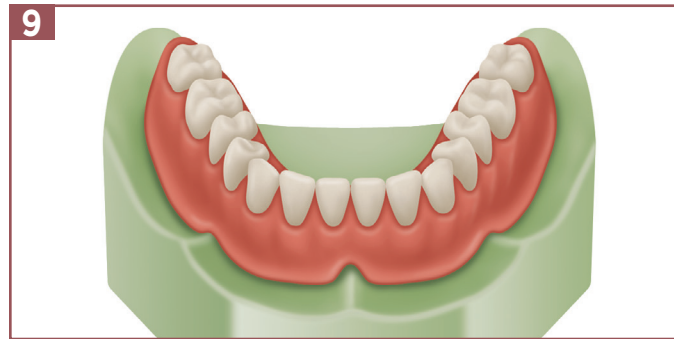

**9** Finalize and flask the overdenture for processing. Separate the flask and boil away all wax. Place the Denture Attachment Housings with Black Processing Inserts on the Analogs and press down firmly. Place the cast back into the flask and verify that there is no contact with the teeth. Close the flask and process the overdenture. Remove the overdenture from the flask, finish, and polish.

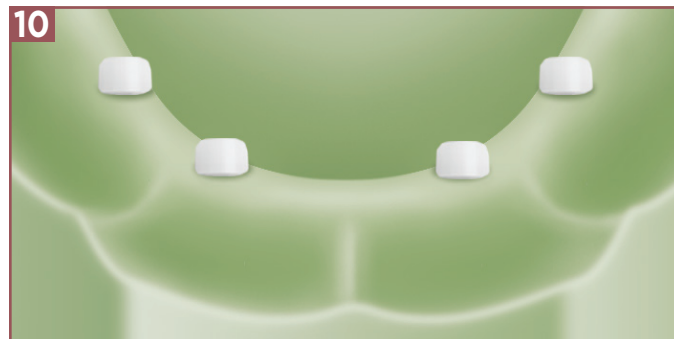

**10 Optional Step:** A Processing Spacer could be used instead of the Denture Attachment Housing during the fabrication of the overdenture if the clinician prefers to pick up the Denture Attachment Housings chairside. The Processing Spacer creates a recess in the denture to allow for the Denture Attachment Housing to be seated without any interference with the surrounding denture acrylic.

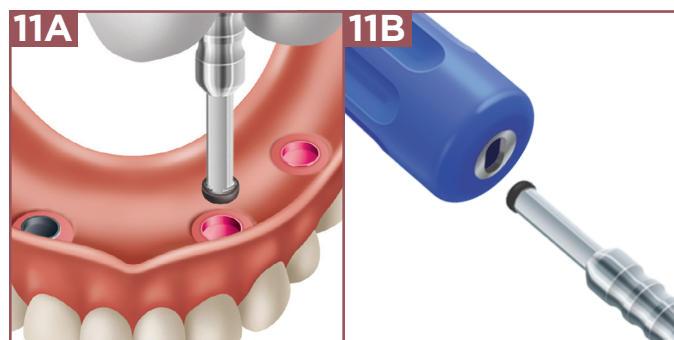

**11A-11B** Remove the Black Processing Insert from the Denture Attachment Housing using the removal (OUT) end of the Retention Insert Tool. When using the removal end of the Tool, engage the Processing Insert and tip the Tool towards the distal or mesial of the intaglio surface until the Insert completely disengages from the Denture Attachment Housing.

Use the metal slot feature on the back end of the Tool to remove the Insert from the tip of the Tool. This can be accomplished by sliding the Insert into the opening of the metal slot and using an upward motion to remove the Insert.

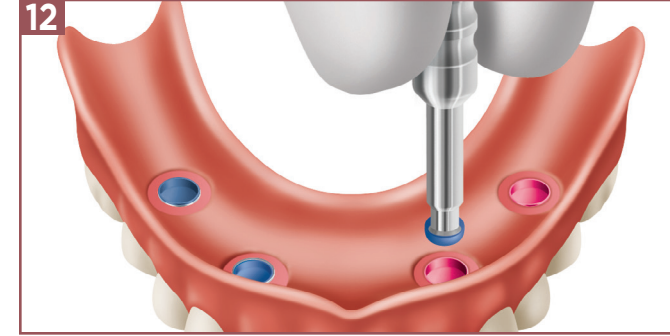

**12** Place the selected final Retention Insert into each Denture Attachment Housing using the insertion (IN) end of the Tool. During try-in, start with the lowest retentive option. When using the insertion end of the Tool, engage the Retention Insert from a slight angle and upright the Tool while pressing down.

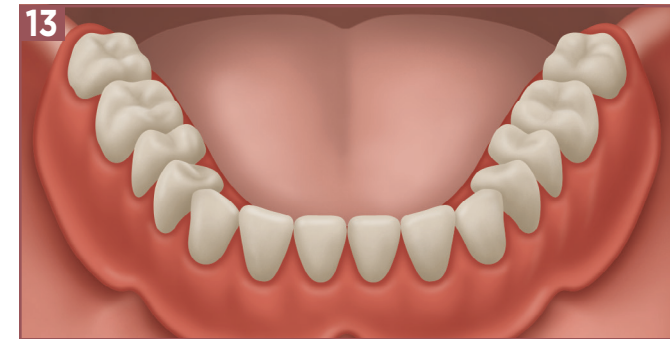

**13 DELIVERY**  
Place the overdenture in the mouth and press down to engage the Retention Inserts on the R-Tx Abutments. Verify the occlusion. Instruct the patient on how to remove and insert the overdenture. If the retention is not satisfactory, remove the Retention Inserts and replace with the next level of retention. Please refer to the Retention Inserts section of the Components Reference on page 2 for available levels of retention. Instruct the patient on proper home care maintenance and required recall visits.



# MAINTENANCE OF THE LOCATOR R-Tx® ABUTMENT

Reline of Implant-Retained Tissue Supported Overdentures

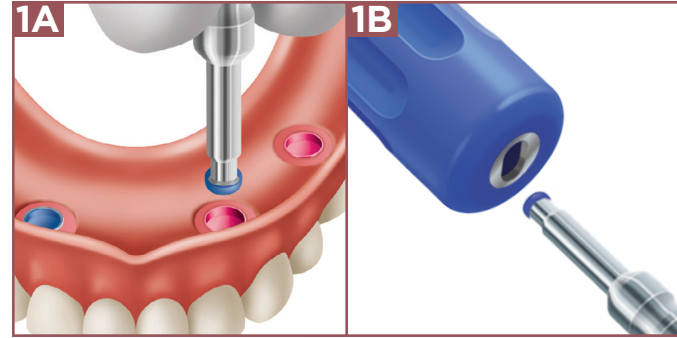

**1A-1B** Remove the Retention Inserts from the denture using the removal (OUT) end of the Retention Insert Tool. When using the removal end of the Tool, engage the Retention Inserts and tip the Tool towards the distal or mesial of the intaglio surface until the insert completely disengages from the Denture Attachment Housing.

Use the metal slot feature on the back end of the Tool to remove the Insert from the tip of the Tool. This can be accomplished by sliding the Insert into the opening of the metal slot and using an upward motion to remove the Insert.

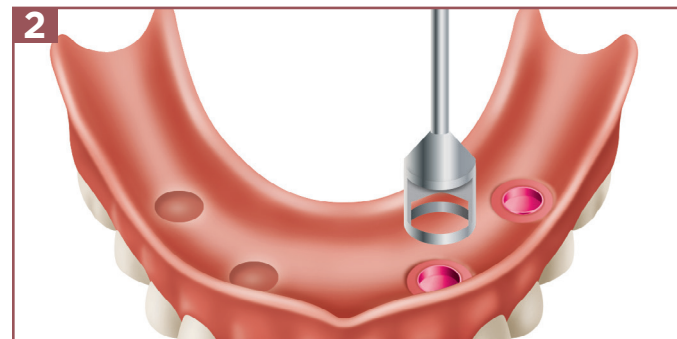

**2** Using a trephine bur, remove the existing Denture Attachment Housings from the overdenture.

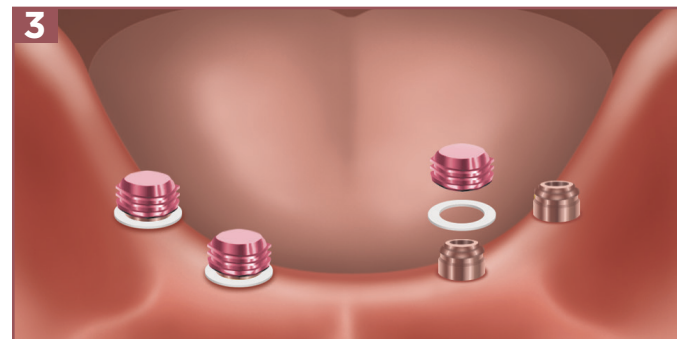

**3** Place a white Block-Out Spacer around each Abutment and press it down to the tissue. Snap a new Denture Attachment Housing with a pre-inserted Black Processing Insert onto each Abutment, pressing down firmly. Try in the overdenture to ensure each recess is large enough to accommodate the new Denture Attachment Housing with no interference with the acrylic.

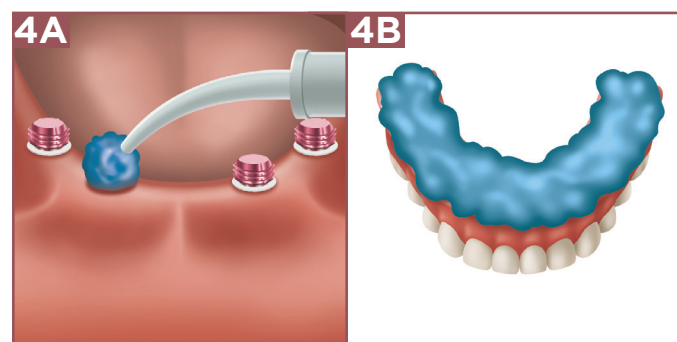

**4A-4B** Apply impression adhesive to the intaglio surface of the overdenture and apply a medium body impression material. Take an impression and have the patient close into light centric occlusion. Remove the overdenture and verify that all the Denture Attachment Housings are picked up in the impression.

# MAINTENANCE OF THE LOCATOR R-Tx® ABUTMENT

Reline of Implant-Retained Tissue Supported Overdentures (continued)

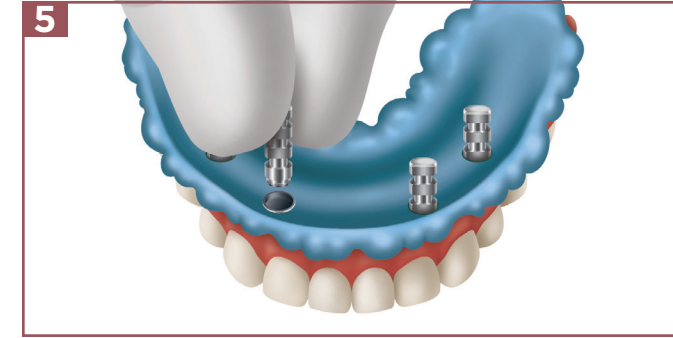

**5** Seat the appropriate diameter LOCATOR R-Tx Analog into each Denture Attachment Housing and pour a model.

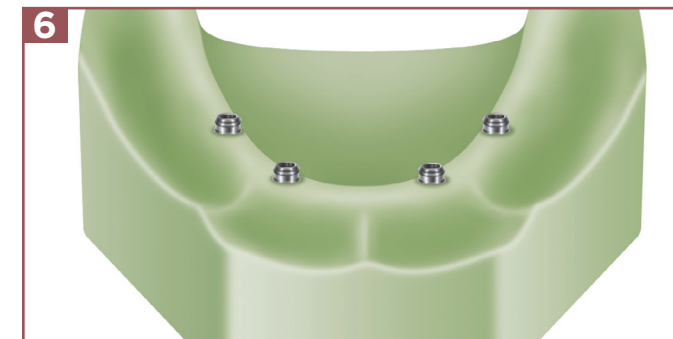

**6** Verify that the Analogs are secure in the Black Processing Inserts and pour a master cast.



**7** Mount the cast with the denture in a reline jig.

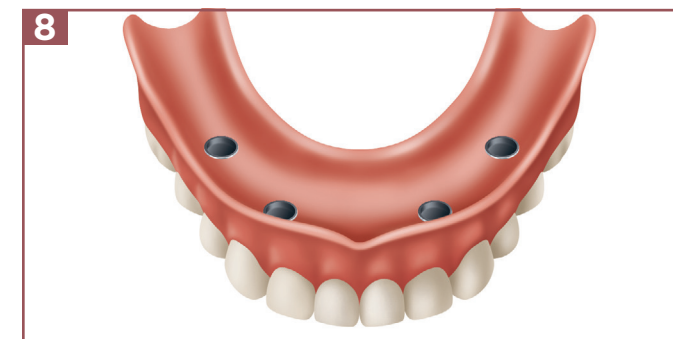

**8** Separate the reline jig and remove the impression material from the overdenture. Seat the overdenture and the Denture Attachment Housings back on the Analogs and reline.

Remove the overdenture from the reline jig, finish and polish.

# MAINTENANCE OF THE LOCATOR R-Tx® ABUTMENT

Reline of Implant-Retained Tissue Supported Overdentures (continued)

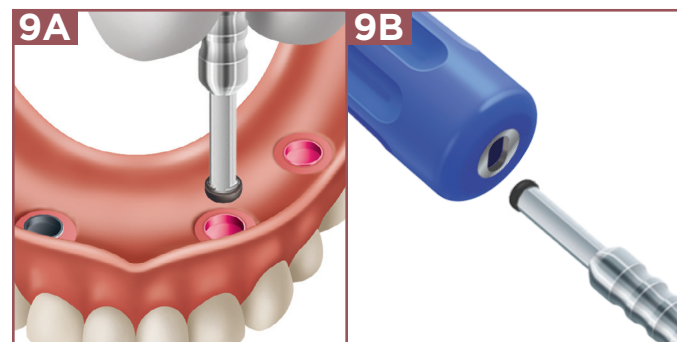

**9A-9B** Remove the Black Processing Inserts from the denture using the removal (OUT) end of the Retention Insert Tool. When using the removal end of the Tool, engage the Processing Inserts and tip the Tool towards the distal or mesial of the intaglio surface until the Insert completely disengages from the Denture Attachment Housing.

Use the metal slot feature on the back end of the Tool to remove the Insert from the tip of the Tool. This can be accomplished by sliding the Insert into the opening of the metal slot and using an upward motion to remove the Insert.

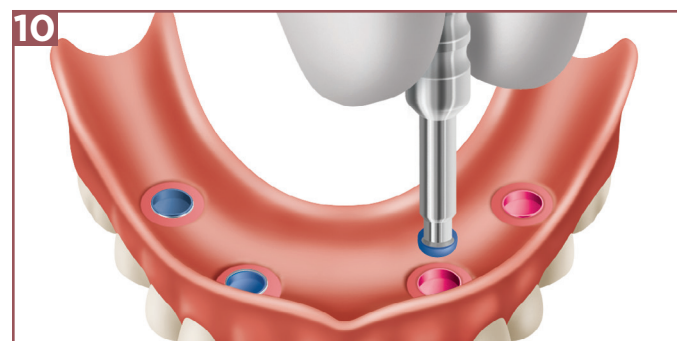

**10** Place the selected final Retention Insert into each Denture Attachment Housing using the insertion (IN) end of the Tool. During try-in, start with the lowest retentive option. When using the insertion end of the Tool, engage the Retention Insert from a slight angle and upright the Tool while pressing down.

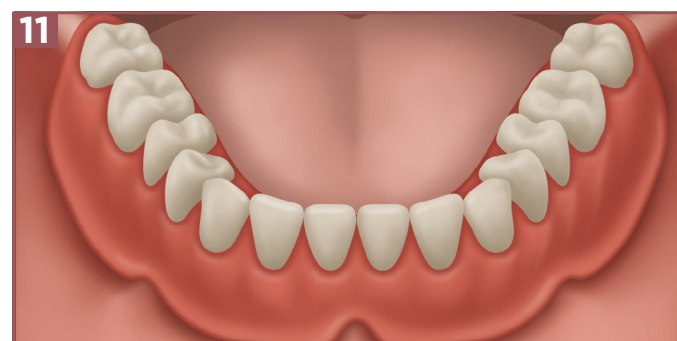

## **11** DELIVERY

Place the overdenture in the mouth and press down to engage the Retention Inserts on the Abutments. Verify the occlusion. If the retention is not satisfactory, remove the Retention Inserts and replace with the next level of retention. Please refer to the Retention Insert section of the Components Reference on page 2 for available levels of retention. Instruct the patient on proper home care maintenance and required recall visits.

# RETURN POLICY AND WARRANTY

## ORDERING

Orders are accepted by internet, email, mail, fax, or phone. Regular business hours are 7:00am to 5:00pm PST (Pacific Standard Time). Domestic orders received by 1:00pm PST can be shipped by ground the same day. Orders received by 3:00pm PST can be shipped by express. Institutional orders require a purchase order number.

## PRICING

Zest Dental Solutions® makes every effort to maintain a competitive pricing structure. Pricing is subject to routine review and change without prior notice.

## TERMS AND BILLING

- A. Credit Card:** Payment at the time of order with VISA, AMERICAN EXPRESS, DISCOVER or MASTERCARD is necessary for customers not approved for open account billing or special financing offers.
- B. C.O.D.:** Delivery can also be made by C.O.D. freight collect.
- C. Open Account:** An open account can be established by completing a credit application and receiving approval by Zest Dental Solutions. The terms of orders purchased under open accounts are net 30 days.
- D. Export Orders:** Individual orders shipped outside the U.S. require payment in advance or a letter of credit.
- E. Past Due Accounts:** Past due balances will be subject to a 1.5% finance charge per month, amount equal to 18% per annum.

## SHIPPING CHARGES

Merchandise is shipped prepaid by Zest Dental Solutions with the cost added to the invoice, or freight collect with C.O.D. fee included in the case of C.O.D. shipments. Delivery options include Fed Ex ground, 3-day, 2-day, or overnight rush service.

## LIMITED WARRANTY

Zest Dental Solutions provides a limited warranty for its products, to the original purchaser, to be free from defects in workmanship and materials under normal use and service, for a period of one year from the date of purchase with the exception of LOCATOR

and LOCATOR R-Tx abutments which carry a three year limited warranty (when purchased directly from Zest Dental Solutions) and a two year limited warranty when purchased from one of our partners. Zest Dental Solutions will, at its option, substitute the returned product that proves defective within the warranty period, with a similar product, free of charge.

Zest Dental Solutions continually strives to improve its products, and therefore, reserves the right to improve, modify, or discontinue products at any time without notice or incurring obligations. Purchaser assumes all risks and liability resulting from the use of ZEST Products, whether used separately or in combination with other products not of Zest Dental Solutions manufacture.

## RETURN POLICY

Please Observe the Following Guidelines:

- A.** Authorization for returns must be received from Zest Dental Solutions prior to the return of any product. A Return Material Authorization (RMA) number will be provided for all returns.
- B.** Shipping charges must be prepaid by the customer to accept a return shipment.
- C.** Returned products are subject to a \$20 restocking fee for orders under \$400. For orders \$400 to \$1,000, a \$40 restocking fee will be applied. For orders exceeding \$1,000, please contact your Customer Service Representative for the restocking fee.
- D.** Returned merchandise will be accepted within 90 days of purchase if product is in saleable condition (in its original unopened package and not marred by any added writing or over-labeling).
- E.** Returns will not be accepted after 90 days of purchase.
- F.** Non-returnable items include:
  - 1.** Merchandise retained beyond expiration date noted on the package.
  - 2.** Packages with broken seals or missing parts
  - 3.** Used, damaged, or obsolete products will not be accepted for return.



VISIT  
**ZESTDENT.COM**

24 HOURS A DAY, 7 DAYS A WEEK,

TO PLACE ORDERS ONLINE OR TO FIND THE  
LATEST SUPPORT TOOLS FOR LOCATOR R-Tx®



**ZEST DENTAL SOLUTIONS**  
2875 LOKER AVENUE EAST  
CARLSBAD, CA 92010  
USA

TEL: 800.262.2310  
FAX: 760.743.7975  
EMAIL: SALES@ZESTDENT.COM  
**WWW.ZESTDENT.COM**

---

DISTRIBUTED BY: